



# BKHD-1140N4L Motherboard

VER 1.0

## Copyright Notice

©2026 Beikong Industrial Control. All rights reserved.

All trademarks, service marks, company names, and logos referenced in this manual are the property of their respective owners. Any use of these trademarks, service marks, company names, and logos without express written permission from Beikong Industrial Control or the respective trademark owners is strictly prohibited.

## Responsibility Statement

This user manual and its contents, including text, images, charts, and other materials, are protected by copyright law and are the property of Beikong Industrial Control. Please be advised that without the written permission of Beikong Industrial Control, the manual may not be copied, distributed, displayed, modified, created as a derivative work, transmitted, or publicly performed or displayed in any way or form.

Beikong Industrial Control reserves the right to modify the product specifications, features, designs, or any related information mentioned in this user manual at any time without prior notice. Please be advised that any such modifications will take effect without further notice.

Any reproduction, modification, reprinting, transmission, or publication of the contents of this manual in any form without prior written permission from Beikong Industrial Control is strictly prohibited. Any violation of this statement may result in legal action and damages.

## Safety Guide

To ensure optimal use of Beikong products, please review the user manual in its entirety. Before reviewing product-specific information, we kindly request that you carefully read the safety instructions.

## Product Version Identification

The product version number can be found on the motherboard, where X.X represents a number. For example, if the version is indicated as [VER1.0], it signifies that the current version of the motherboard is 1.0. The BIOS interface homepage provides information such as [XXXXNP-XXXX], which denotes the BIOS version number utilized by the current product. When updating the motherboard's BIOS, driver, or referencing other technical documents, please refer to the product version label for the most up-to-date information.

## Catalog

Copyright Notice .....	1
Responsibility Statement .....	1
Safety Guide .....	1
Product Version Identification .....	1
Product Images .....	3
Block Diagram .....	4
Product Profile .....	5
Motherboard Specifications .....	6
Motherboard Installation .....	7
Memory Installation .....	8
Motherboard Interface & Pin Description .....	9
Jumper Setting .....	11
Restore on AC/Power Loss (AUTO_ON) .....	11
RST GPIO Function Selection Jumper (RST GPIO) .....	11
Motherboard Pin Definition .....	12
SATA Data .....	12
SATA PWR .....	12
Serial Port (COM) .....	13
RS485 Select Jumper for COM2 (JC22) .....	13
Pin 9 Voltage Selection Jumper for COM1-2 (JC 11/21) .....	13
Front Panel Connectors (F_PANEL) .....	14
Cooling Fan Power Socket .....	14
SIM card slot (SIMB) .....	14
BIOS User Guide .....	15
BIOS Description .....	15
BIOS Settings .....	16
Common Fault Analysis And Solutions .....	17
Useful Links .....	18

# Product Images

Please be advised that products manufactured in different batches may exhibit slight variations in appearance. To ensure the most accurate representation, please refer to the actual received goods.

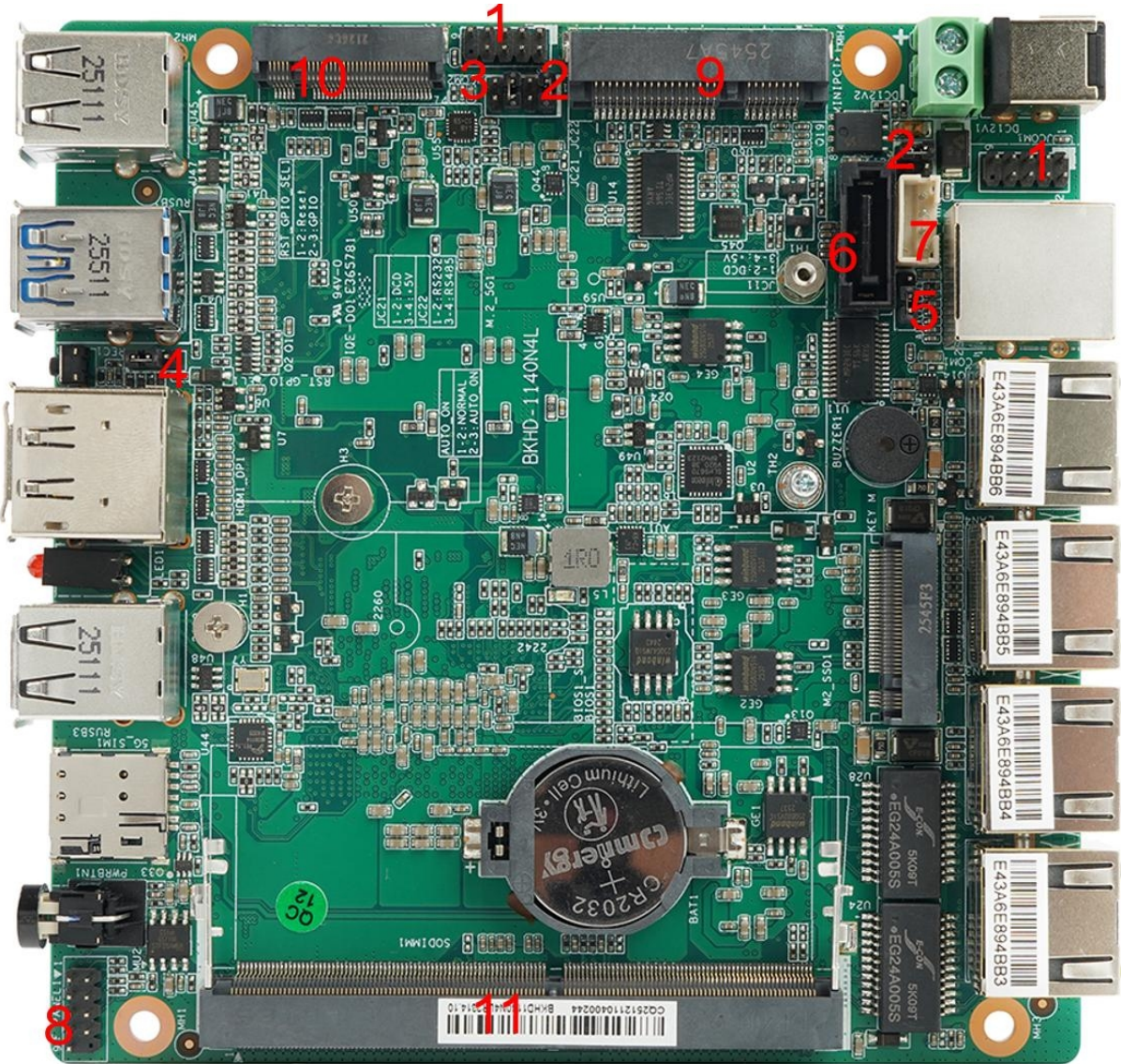

# Block Diagram

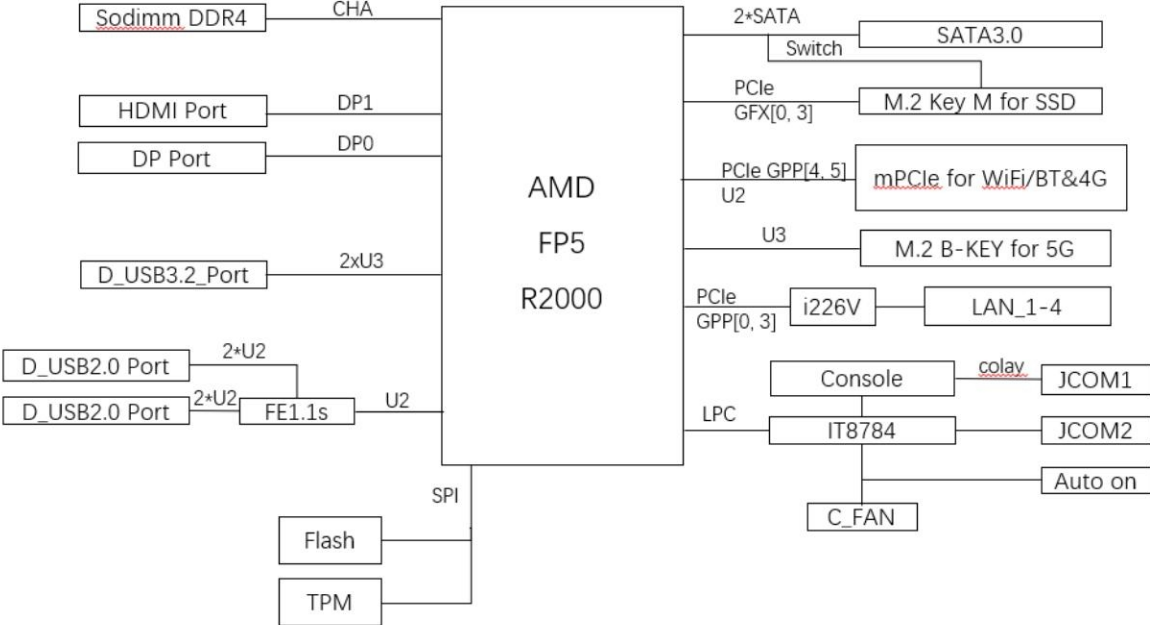

## Product Profile

The BKHD-1140N4L is a compact embedded industrial motherboard powered by AMD Ryzen Embedded R2000 series processors. Within a space-efficient form factor, it integrates 4x 2.5GbE Ethernet ports, high-performance AMD Radeon graphics, rich expansion interfaces, and industrial-grade reliability. Designed for applications requiring high network bandwidth, strong graphics performance, and compact deployment, it is ideal for industrial gateways, edge computing, network security, digital signage, and self-service terminals.

Main features:

### High-Speed Networking Performance

Equipped with four Intel I226V 2.5GbE controllers, delivering up to 10Gbps aggregate bandwidth. It provides ample throughput for multi-WAN routing, high-performance firewalls, SD-WAN, and industrial IoT gateways, easily handling large-scale packet forwarding and complex network policies.

### Powerful Computing and Graphics

Powered by the AMD Ryzen Embedded R2314 processor, offering excellent performance and energy efficiency for industrial applications. Integrated AMD Radeon graphics support dual independent displays (DP+HD) with strong 4K decoding and rendering capabilities, making it ideal for advanced HMI, digital signage, and video monitoring.

### Ultra-Compact Design

Built on a Nano-ITX form factor, the board maximizes space efficiency, enabling easy integration into compact and high-density embedded systems.

### Rich Industrial Connectivity

Includes 1x RJ45 console port and J\_COM headers for flexible expansion of multiple RS232 serial ports, supporting PLCs, industrial instruments, and barcode scanners. Rear I/O provides 2x USB 3.2 and 4x USB 2.0 ports for high-speed data transfer and peripheral connectivity.

### Flexible Expansion and Storage

Features mPCIe and M.2 Key-B slots for Wi-Fi, Bluetooth, and 4G/5G modules, along with an onboard SIM card slot for cellular connectivity. Storage options include 1x SATA 6Gb/s and 1x M.2 (Key-B+M 2280), enabling flexible configurations for high-speed SSDs and large-capacity storage.

## Motherboard Specifications

Processor	Product Collection	AMD Ryzen Embedded R2314
	Sockets Supported	FP5
Memory specifications	Memory Type	DDR4 SO-DIMM
	Maximum Capacity	32GB
	Maximum Frequency	2666MHz
Storage specifications	SATA	1*SATA 6Gb/s
	M.2	1*M.2 Key-B+M(PCIe 3.0 x4/SATA)
Network features	Ethernet	4*2.5GbE
	Controller	4*Intel I226V
Extension interface	mPCIe	1*mPCIe (PCIe+USB2.0 signal)
	M.2	1*M.2 Key-B (USB3.0 signal)
Display functions	Pins	1*DP/1*HD
	Chip	AMD Radeon RX Vega 6
I/O Chip	Chip	IT8784E-I
Backplane I/O	Ethernet	4*RJ45
	USB	2*USB-A 3.2, 4*USB-A 2.0
	Console	1*RJ45 COM
	Button	1*Power button, 1*Reset button
	Power supply	1*Jack DC 5.5/2.5mm
Onboard I/O	SATA	1*SATA Data connector, 1*SATA Power socket
	SIM	1*SIM Card slots
	Fan	1*CPU_FAN
	Pins	1*F_PANEL
		2*J_COM
Power supply mode	Power	1*Jack DC 12V
Motherboard size	Specification	120*120 (mm)
Work Environment	Temperature	0~60℃ (Operating); -20℃~75℃ (Storage)
	Humidity	0%~95% (Relative humidity, no condensation)

# Motherboard Installation

## Safety Note

- Please do not remove the serial number and agent warranty sticker from the motherboard prior to installation. Doing so may affect the product's warranty recognition standard.
- Prior to installing or removing the motherboard or other hardware devices, please ensure that the power is turned off and the power cord is unplugged from the socket.
- When installing additional hardware devices on the motherboard interfaces, please ensure that the connectors and sockets are securely fastened.
- When handling the motherboard, please avoid contact with the metal wiring components to prevent the risk of short circuits.
- It is recommended that an anti-static wrist strap be worn when handling the motherboard, central processing unit (CPU), or memory. In the absence of an anti-static wrist strap, it is advisable to ensure that your hands are dry and to touch a metal object first in order to eliminate static electricity.
- Before installing the motherboard, we kindly request that place it on an antistatic mat or in an antistatic bag.
- Make sure the power adapter is turned off before unplugging the motherboard power connector.
- Before turning on the power, make sure the voltage of the adapter is within the standard voltage range.
- Before turning on the power, make sure all hardware device cables and power cords are properly connected.
- Do not allow the fixing screws to collide with the circuits or parts on the motherboard to avoid damage or malfunction of the motherboard.
- Make sure there are no loose screws or metal parts on the motherboard or inside the computer case before using the unit.
- Please secure the computer host in a stable location before starting the device.
- To prevent system failure, do not place the unit in an environment where the temperature is excessive.
- Turning on the power before installation is complete may damage the motherboard, other equipment, or yourself.
- If you are unfamiliar with how to perform the installation, or if you have any technical problems using this product, please contact a professional technician.

## Memory Installation

The motherboard provides DDR4 SODIMM memory slot.

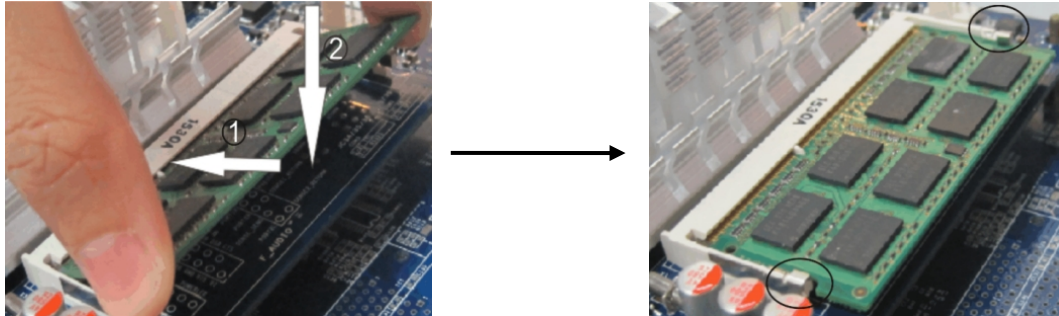

### **Before installing memory:**

1. Please confirm that the memory you purchased is compatible with the specifications supported by this motherboard.
2. Before installing or removing the memory, please make sure that the power of the computer is turned off to avoid damage.
3. The memory design has a foolproof mark. If you insert the memory in the wrong direction, the memory cannot be installed. Please change the direction.

### **When installing memory:**

1. Before installing or removing memory, please turn off the power and unplug the power cord.
2. Carefully hold the two ends of the Memory Stick and do not touch the metal contacts on the Memory Stick.
3. Align the metal contacts of the memory with the memory slot, making sure that the concave hole is aligned with the convex point of the upper slot.
4. Insert the memory into the slot at an angle of 30 degrees, then press the Memory Stick down until you hear a "click," indicating that the memory has been successfully installed and is ready to use. (Note: Do not press the Memory Stick too hard to avoid damaging the memory).
5. To remove the Memory Stick, push out the tabs at both ends of the memory slot simultaneously, and then remove the Memory Stick.

### **To remove the memory:**

Use two fingers to push the latches at either end of the slot outward, the memory will pop up, then remove the memory.

# Motherboard Interface & Pin Description

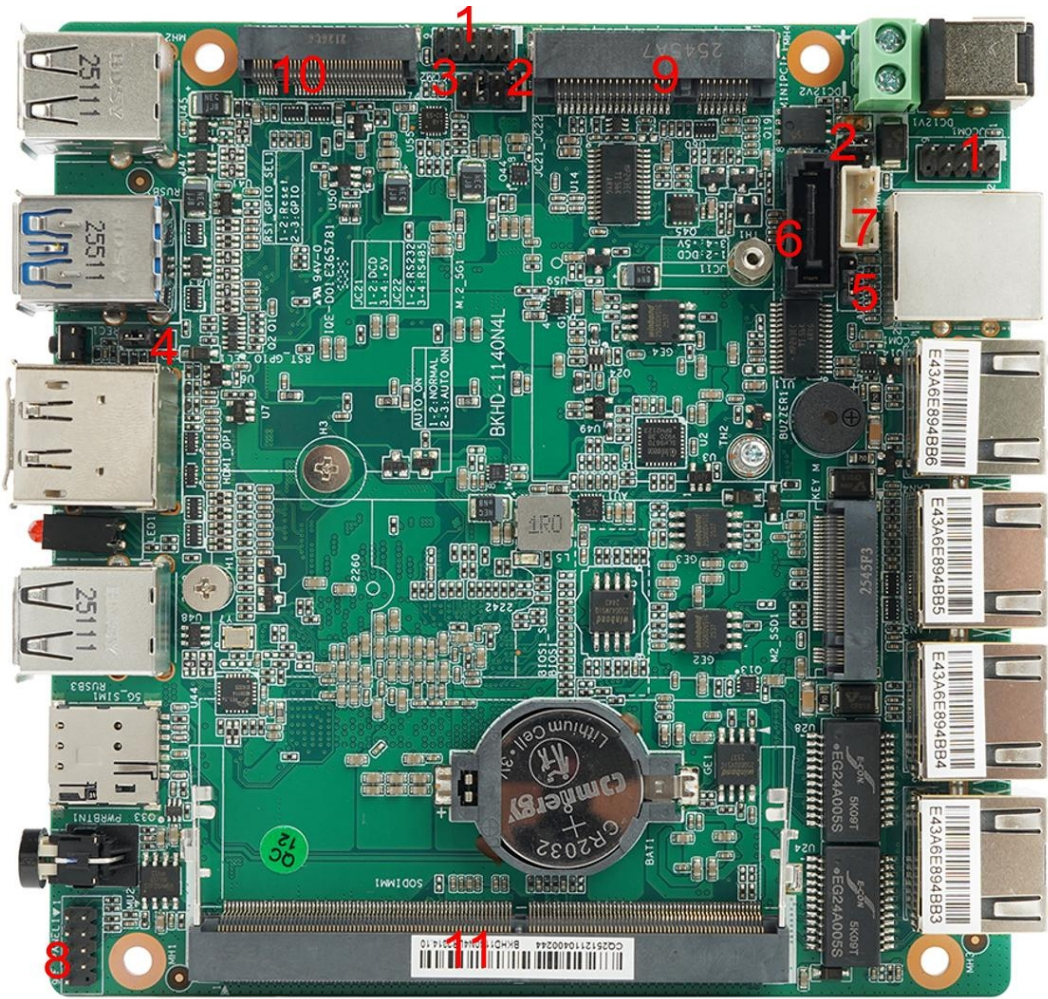

Item	Describe
1	COM 1/2 Can be used to expand COM ports
2	JC 11/21 COM 1/2 voltage selection jumper
3	JC 22 RS485 select jumper for COM2
4	RST_GPIO RST GPIO function selection jumper
5	AUTO_ON Restore on AC function jumper
6	SATA SATA HDD/SSD Data Connectors
7	SATA_PWR SATA HDD/SSD Power Socket
8	F_PANEL Motherboard function pin, used to connect chassis button

9	MINI PCIE	Mini PCIe slot
10	M.2_5G	M.2 Key-B 3052 slot for 4G/5G cellular module
11	SODIMM	DDR4 SO-DIMM memory slot (RAM)

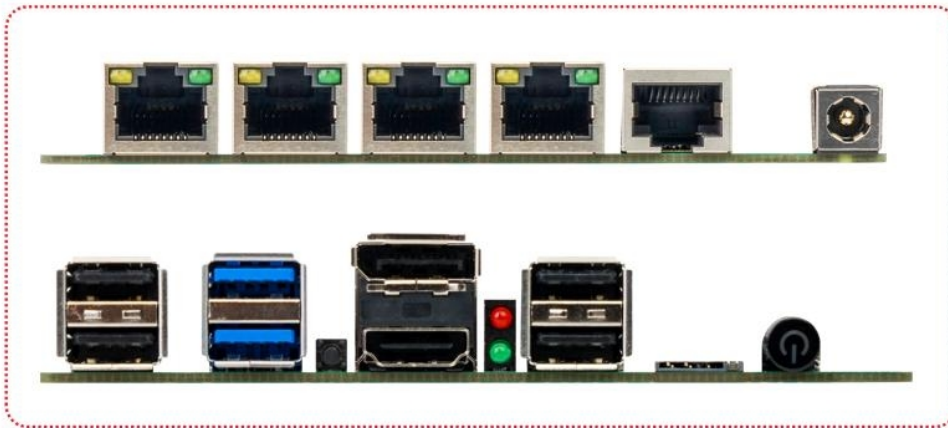

Item	Describe
RJ45 Connectors	RJ45 Ethernet port for LAN/WAN Link LED: Green and solid, indicating the network is connected Active LED: Orange flashing, indicating data transmission
COM	RJ45 port for COM RS232 standard
DC_IN	Power adapter for connecting Jack DC 5.5/2.5mm 12V
USB 2	Double-layer USB-Type-A 2.0 port
USB 3	Double-layer USB-Type-A 3.2 port
RST_BTN	Reset Button
DP+HD	DP and HD display ports
PWR_LED	LED Indicator (Power: Green; Hard disk: Red)
SIM	SIM Card slot
PWR_BTN	Power Button

## Jumper Setting

Before installing the hardware device, you can set the corresponding jumpers according to your needs based on the following table.

### To identify the first pin of a jumper or connector

Look at the marking next to the jumper or connector. The triangle symbol "▲" or "1" or a bold line indicates the first pin; check the pad on the back of the motherboard. The square pad is the first pin. When connecting the connector to the device, be careful to distinguish the first pin. Mixing the pins will damage the motherboard.

**2-pin headers:** Insert a jumper cap into both pins turns them off (short).

**3-pin headers:** Insert a jumper cap into pins 1-2 or pins 2-3 to off (short) them.

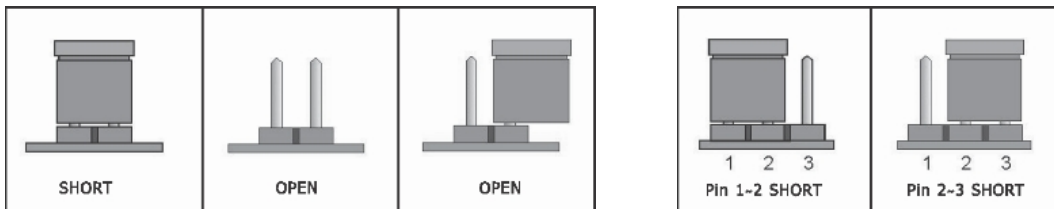

## Restore on AC/Power Loss (AUTO\_ON)

Image	Status	Setting
	1-2	Normal (Default)
	2-3	Automatic power on

## RST GPIO Function Selection Jumper (RST GPIO)

Image	Status	Setting
	1-2	Reset (Default)
	2-3	GPIO

## Motherboard Pin Definition

### SATA Data

The motherboard provides 7-pin SATA data socket

Image	PIN	Definition	PIN	Definition
	1	GND	2	SATA_TXP
	3	SATA_TXN	4	GND
	5	SATA_RXN	6	SATA_RXP
	7	GND		-

### SATA PWR

The motherboard provides 4-pin SATA power socket

Image	PIN	Definition
	1	+5V
	2	GND
	3	GND
	4	+12V

## Serial Port (COM)

The motherboard provides RJ45 COM port

Image	PIN	Definition	PIN	Definition
	1	RTS#	2	DTR#
	3	TXD	4	N/A
	5	GND	6	RXD
	7	DSR#	8	CTS#

The motherboard provides COM pins (2\*5-pin, 2.00 mm pitch, 10th pin is empty)

Image	PIN	Definition	PIN	Definition
	1	DCD#	2	RXD
	3	TXD	4	DTR#
	5	GND	6	DSR#
	7	RTS#	8	CTS#
	9	RI#		

## RS485 Select Jumper for COM2 (JC22)

Image	Status	Definition
	1-2	RS-232
	3-4	RS-485

## Pin 9 Voltage Selection Jumper for COM1-2 (JC 11/21)

Image	Status	Definition
	1-2	DCD
	3-4	+5V

## Front Panel Connectors (F\_PANEL)

The motherboard provides F\_PANEL pins (2\*5-pin, 2.00 mm pitch, 10th pin is empty)

Image	PIN	Definition	PIN	Definition
	1	HDD_LED+	2	PWR_LED+
	3	HDD_LED-	4	PWR_LED-
	5	GND	6	POWER-SW
	7	RESET-SW	8	GND
	9	GND		

## Cooling Fan Power Socket

The motherboard provides Cooling Fan pins

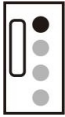
Image	PIN	Definition
	1	Ground
	2	+12V
	3	FAN_TAC
	4	FAN_PWM

## SIM card slot (SIMB)

The motherboard provides SIM card slot for installing an LTE SIM card.



**Note:** When inserting the SIM card, make sure the chip is facing downwards (the chip faces the motherboard).

# BIOS User Guide

## BIOS Description

This motherboard uses AMI BIOS. BIOS stands for (Basic Input Output System). It is a set of programs stored on a ROM (Read Only Memory) chip on the computer's motherboard. It stores the computer's most important basic I/O programs, the power-on self-test program, and the system startup program. It can read and write specific information about system settings from the CMOS. Its primary function is to provide the most basic and immediate hardware settings and control for the computer.

When you turn on your computer, the BIOS is the first program to run. It has the following main functions:

- The Power-On Self-Test (POST) checks whether the computer is functioning properly.
- It initializes and tests some external devices and loads your operating system.
- It provides the lowest-level, most basic control of your computer hardware.
- You manage your computer through the SETUP function in the BIOS.

The BIOS data is stored in a CMOS/RAM chip on the motherboard, maintained by a 3.3V button battery. It contains important system information and the BIOS Setup program for setting system parameters. When the system is operating normally, the BIOS does not need to be modified. However, if the CMOS data is lost due to other reasons, the BIOS must be reset.

**Note:**

Incorrect BIOS settings can directly damage the computer hardware and even burn out the motherboard. Those unfamiliar with the system are advised to modify the settings with caution. Because the motherboard BIOS is constantly being updated, the BIOS information in this manual is for reference only. We cannot guarantee that the BIOS information in this manual will be consistent with the actual BIOS information on the motherboard.

## BIOS Settings

When the motherboard is powered on or the system is restarted, the following prompt will appear on the display screen in the Post interface. Press "DEL" on the keyboard to enter BIOS Setup.



If this message disappears before you respond, you can press <Ctrl> + <Alt> + <Del> at the same time to restart the computer, or shut down and then restart the computer, or press the power button on the case to restart the computer.

Keyboard keys	Functional Description
← / →	Move the Left and Right arrows to select the screen.
↑ / ↓	Move the Up and Down arrows to select the item.
+ / -	Increase/Decrease value or Change selection
<Enter>	Select, Confirm this option or Enter the submenu
<ESC>	Return to Main page, or End the setup process from Main page
<F1>	Show related Help instructions
<F2>	Restore previous settings
<F9>	Load the optimized settings (BIOS defaults)
<F10>	Save the changed settings and reboot

## Common Fault Analysis And Solutions

We have compiled some frequently asked questions for your reference. Please check <https://bkminipc.com/frequently-asked-questions-and-answers/>

Error	Inspection Method
Unable to start after power on	<p>Make sure the power cord is properly connected.</p> <p>Make sure that the power supply you are using meets the power supply requirements of the motherboard.</p> <p>Try to reinsert the Memory Stick.</p> <p>Try to replace the Memory Stick.</p> <p>Try to clear the CMOS of the main board.</p> <p>Please confirm if there is an external expansion card and if it is normal after removing the external card.</p>
Unable to display after power on	<p>Make sure the monitor is turned on.</p> <p>Make sure the monitor and host power cables are properly connected. Make sure the monitor and host cables are properly connected.</p> <p>Check to see if the monitor is in "Sleep" mode.</p> <p>Try changing the monitor interface or replacing the monitor.</p>
BIOS Setup cannot be saved	<p>Check that the CMOS battery is installed</p> <p>Try to replace the CMOS battery (CR2032)</p> <p>Adjust the time and date in BIOS setup</p>
Unable to find a bootable device	<p>Make sure the drive's power and data cables are properly connected.</p> <p>Make sure the operating system is installed on the drive.</p> <p>Make sure the hard drive is not physically damaged.</p>
Blue screen or freeze when logging on to the system	<p>Check if the Memory Stick and External Card are loose.</p> <p>Try removing the newly installed hardware and uninstalling the newly installed driver or software.</p> <p>Try replacing the memory with a different specification.</p>
Slow entry into the operating system	<p>Check if the CPU cooling fan is running normally.</p> <p>Check if the remaining space of the system partition is insufficient.</p> <p>Use software to check for bad sectors on the hard drive.</p>
System restarts automatically	<p>Confirm that the CPU cooling fan is rotating normally.</p> <p>Confirm that the switch/reset button has not been accidentally touched.</p> <p>Confirm that the Memory Stick and external card are loose.</p> <p>Confirm that the power supply has sufficient load capacity, try to replace the power supply</p> <p>Check if the system is infected with viruses.</p>
Unable to detect USB device	<p>Confirm that the USB device requires separate power.</p> <p>Confirm that the USB interface has poor contact.</p> <p>Confirm that the USB controller is enabled in the BIOS setup.</p>

## Useful Links

Submit your suggestions and ideas in the community	<a href="https://www.reddit.com/r/bkminipc/">https://www.reddit.com/r/bkminipc/</a>	
Watch our new product demos	<a href="https://www.youtube.com/@BKHD-PCs">https://www.youtube.com/@BKHD-PCs</a>	
Corporate News and Cooperation	<a href="https://www.linkedin.com/company/beikong/">https://www.linkedin.com/company/beikong/</a>	
Get our latest news on Meta	<a href="https://www.facebook.com/people/%E5%80%8D%E6%8E%A7/61558406109357/">https://www.facebook.com/people/%E5%80%8D%E6%8E%A7/61558406109357/</a>	